



- ✓ MECANIZADO IN SITU  
ON SITE MACHINING
- ✓ MECANIZADO  
WORKSHOP MACHINING
- ✓ MATRICERÍA  
DIE METAL STAMP
- ✓ MONTAJES  
ASSEMBLIES
- ✓ CALDERERÍA Y SOLDADURA  
WELDING & STEEL CONSTRUCTION
- ✓ DISEÑO E INGENIERÍA  
DESIGN & ENGINEERING
- ✓ METROLOGÍA  
METROLOGY

**expertos en soluciones metal-mecánicas**  
experts in metal-mechanical solutions



C/ La Palmera n.º 4 - Pol. Ind. III de Moncada  
46113 MONCADA - Valencia  
Tel. +34 96 139 98 40 [www.industa.com](http://www.industa.com)



[www.industa.com](http://www.industa.com)



assemblies  
**montajes**



machining  
on site & workshop

**mecanizado**  
in situ y de taller



experts in  
**expertos en**



tooling  
**utillaje**



welding  
**soldadura**



metal-mechanical  
solutions

**soluciones**  
**metal-mecánicas**



## PRESENTACIÓN PRESENTATION

**INDUSTA** es una empresa integrada en el sector metal-mecánico, fundada en el 1996. Su actividad industrial se centra en la fabricación de maquinaria industrial relacionada con diversidad de procesos industriales. Durante este periodo, **INDUSTA** ha experimentado un ferviente y notable crecimiento a nivel técnico y corporativo que le ha permitido adaptarse a las exigencias y cambios del mercado.

Esto es el resultado de los tres pilares básicos que definen la política interna de la empresa: **calidad en el producto, calidad en el servicio y el fomento de la formación y la mejora continua.**

Nuestra cartera de clientes, actualmente, está formada por importantes grupos de empresas de diferentes sectores industriales, como el siderúrgico, automóvil, energía, aeronáutico, naval, defensa, papel, madera, etc...

Actualmente la empresa dispone de 6.000 m<sup>2</sup> de instalaciones distribuidas entre las diferentes áreas de actividad que permiten atender y dar solución a las necesidades de los clientes. La rapidez de respuesta, la adaptación a los requerimientos del cliente y la calidad de nuestros procesos de fabricación, constituyen nuestro mejor activo para conseguir la satisfacción de nuestros clientes.

**INDUSTA** company is framed in the metal mechanical sector, founded in 1996. Our industrial activity is targeted around the **industrial machinery construction** within a wide diversity of industrial sectors.

Along this period, **INDUSTA** has had a noticeable grow in all aspects like facilities, technical resources and qualified people which has permitted adapt to the market changes and increasing customers demands.

This development is the result of the three main premises which have ruled the company from the beginning: **quality** about the products, **customer satisfaction** and improvement of **technical knowledge and skill perfection.**

In our customer's portfolio, there are international well known companies, spreaded in a great variety of industrial sectors like car industry, shipping construction, aerospace industry, energy, defence companies, steel industry, etc.

At present, **INDUSTA** have 6.000 sq m of facilities distributed in different activity areas which enable the company to attend complex contracts with guarantee about quality and delivery commitment. A quick answer and customer' requirements adaptation together with a high manufacturing quality processes are the more appreciated value pointed out by our customers.

## CALIDAD QUALITY

La **calidad de nuestros productos** y de **nuestros servicios** es tan importante para nosotros como para nuestros clientes, por esta razón fabricamos todas nuestras piezas bajo la certificación ISO 9001:2008 estando certificados en gestión ambiental ISO 14001:2004.

**Products quality** and **service quality** are the top priority for us in order to achieve a complete customer satisfaction. **INDUSTA** is certified by ISO 9001:2008 and ISO 14001:2004 for environmental management.



Empresa Certificada  
ISO 9001:2008  
EC 0516 /12  
ACREDITADO POR  
**ENAC**



## MECANIZADO IN SITU ON SITE MACHINING

**INDUSTA** realiza todo tipo de mecanizados in situ (torneados, fresados, mandrinados, taladrados, rectificados, etc...) sin limitaciones. Adaptamos nuestros equipos a las instalaciones de los clientes, ofreciendo soluciones a sus necesidades.

**INDUSTA** performs any type of machining on site (turning, milling, boring, drilling, grinding, etc...), without limitation and adapting our equipment to each particular requirement, giving solutions to complex problems.

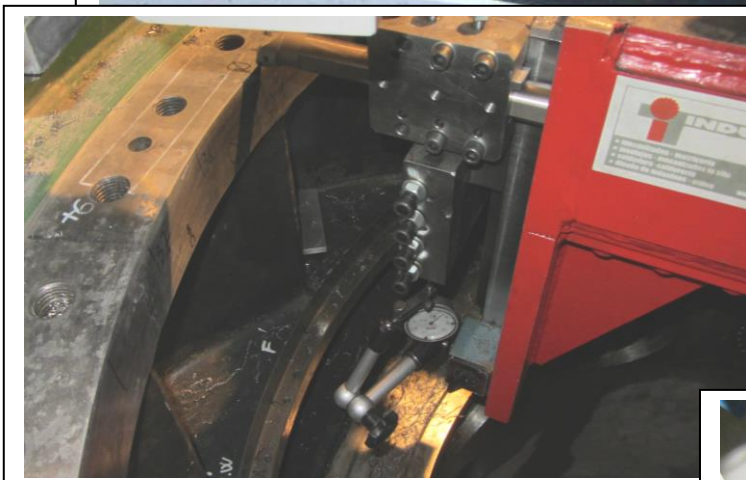

Nuestra ventaja competitiva reside en un equipo de profesionales con amplia experiencia que permiten una respuesta rápida a las necesidades de los clientes, con desarrollos propios que facilitan la solución a planteamientos complejos.

Our **competitive advantage** is based on our professional team with a wide experience in this activity which permit a quick answer to our customer's necessities. Inside this team there are engineers to provide the **best solution** with our own equipment developments.

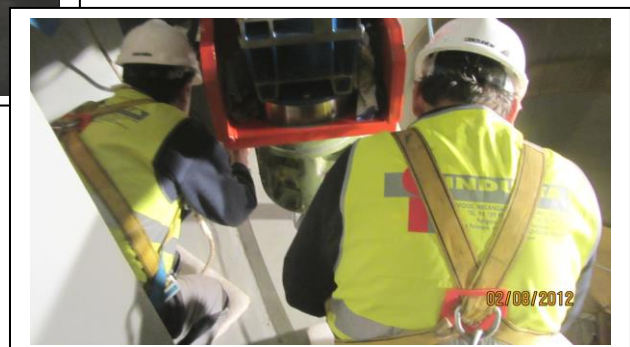



**MECANIZADO IN SITU ON SITE MACHINING**



**SECTOR  
NAVAL**

**SHIPPING  
INDUSTRY**

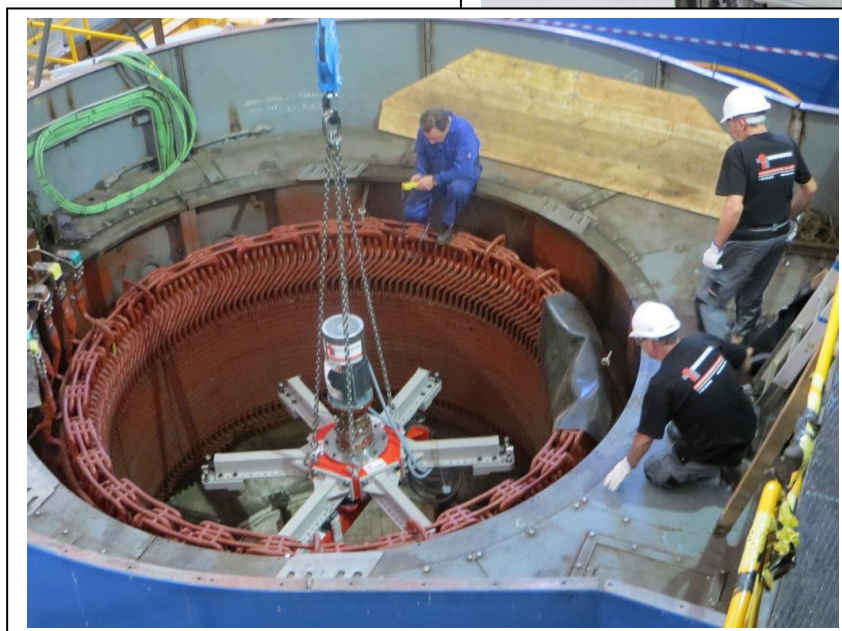

**SECTOR  
ENERGÍA**

**ENERGY  
SECTOR**

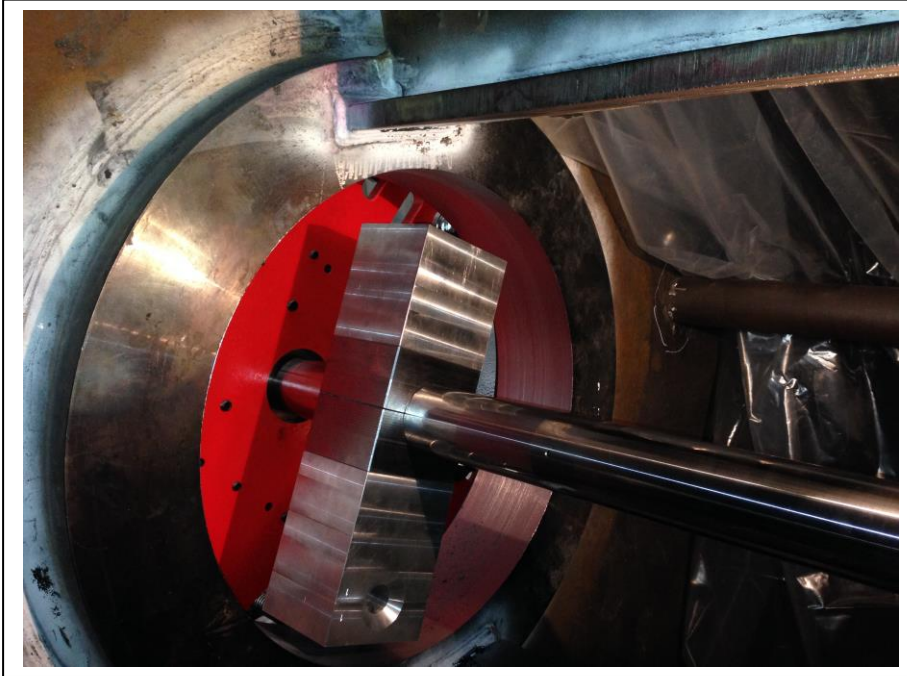
**MECANIZADO IN SITU ON SITE MACHINING**

**INDUSTRIA DE  
PARQUES  
TEMÁTICOS**

**AMUSEMENT  
INDUSTRIES**

INDUSTA desarrolla soluciones para cada necesidad, analizando los condicionantes técnicos, espacios accesibilidad, calendarios de paradas, etc para conseguir los resultados fijados por los clientes.

INDUSTA develops solutions for each particular project, analyzing all technical requirements, available spaces, accessibility, schedule and production calendar, etc to achieve the results appointed by the customers

**SECTOR  
ENERGÍA**

**ENERGY  
SECTOR**





**MECANIZADO IN SITU ON SITE MACHINING**

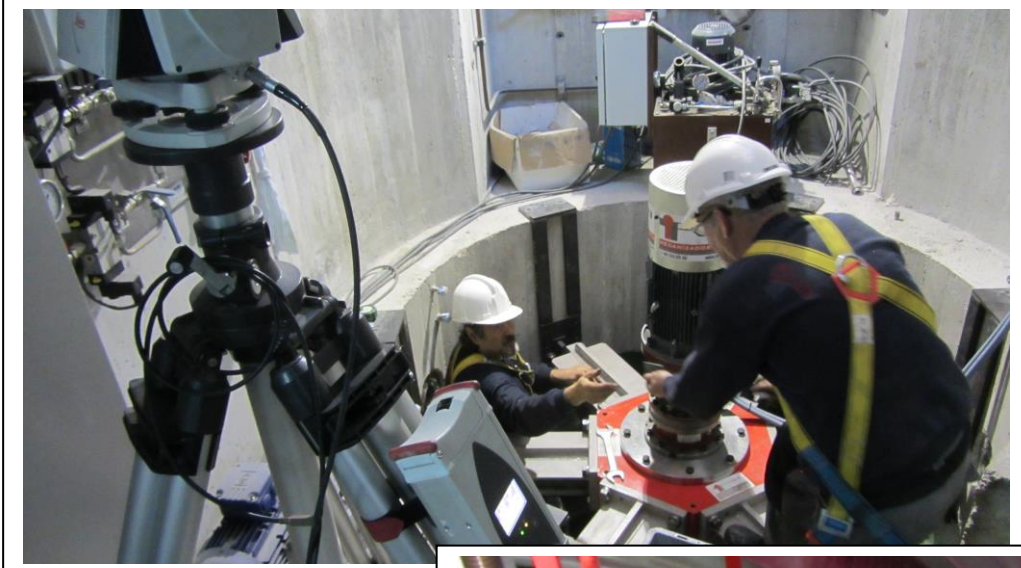

INDUSTA ofrece una rápida respuesta y asesoramos a nuestros clientes con nuestra larga experiencia y herramientas de última tecnología para asegurar el éxito de sus proyectos.

INDUSTA offers a quick answer and give support to our customers with expertise and high-tech tools in machining to assure the success in their projects.

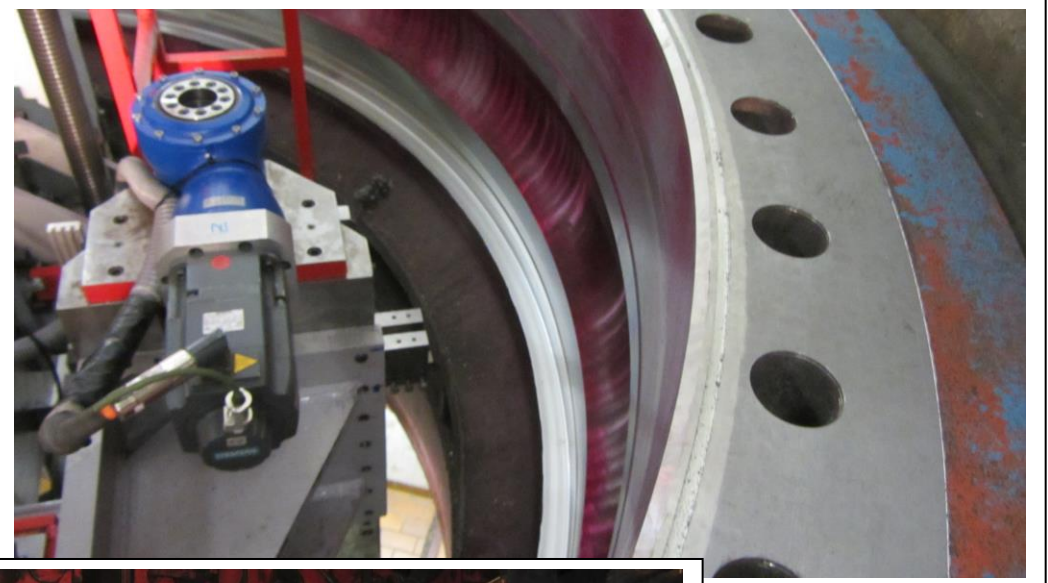

**SECTOR  
SIDERÚRGICO**

**IRON AND STEEL  
INDUSTRIES**

**MECANIZADO IN SITU ON SITE MACHINING**

**SECTOR  
AUTOMÓVIL**

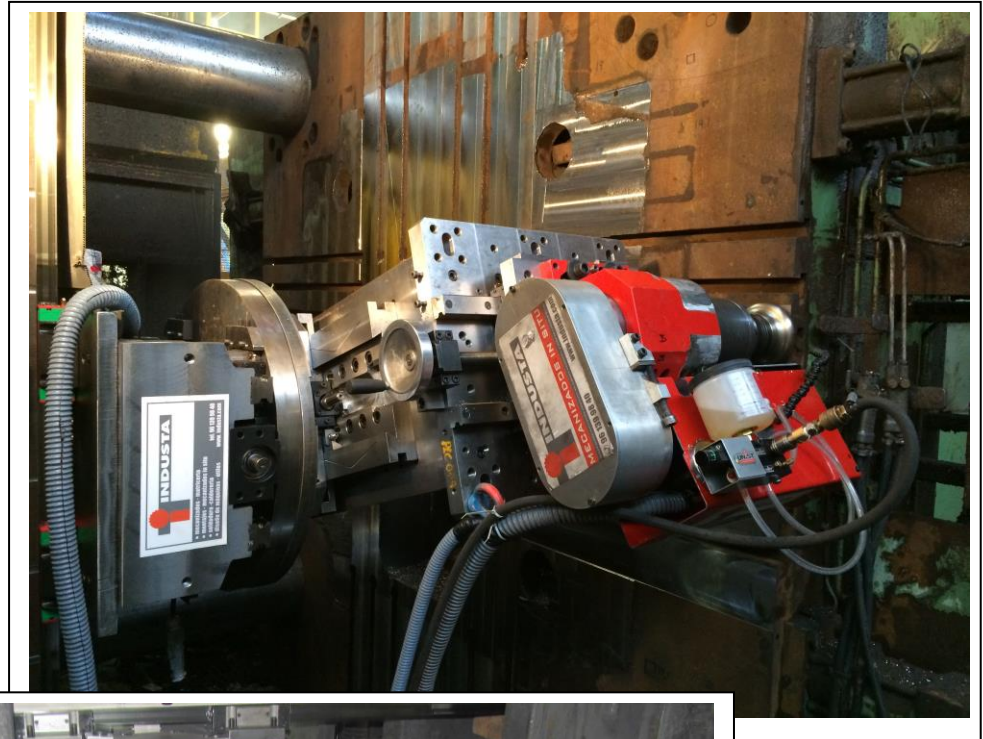

**CAR  
INDUSTRY**





**MECANIZADO IN SITU ON SITE MACHINING**

**SECTOR SIDERÚRGICO**

**IRON AND STEEL INDUSTRIES**

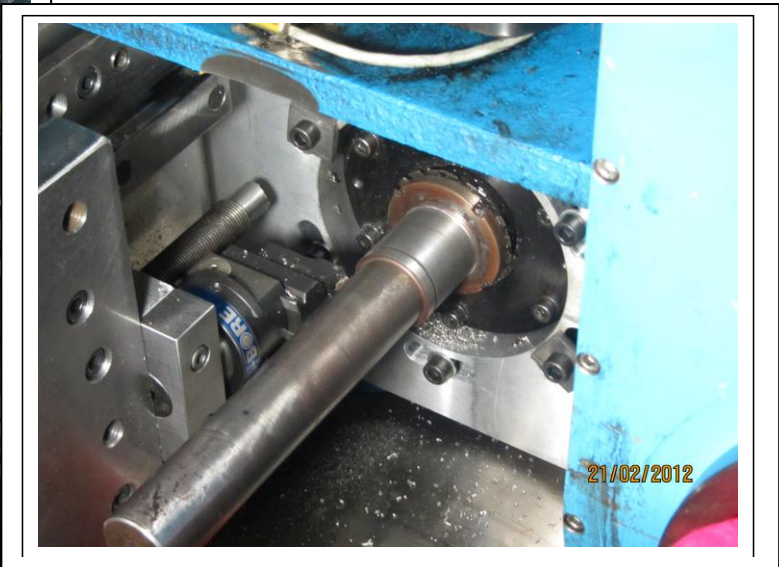
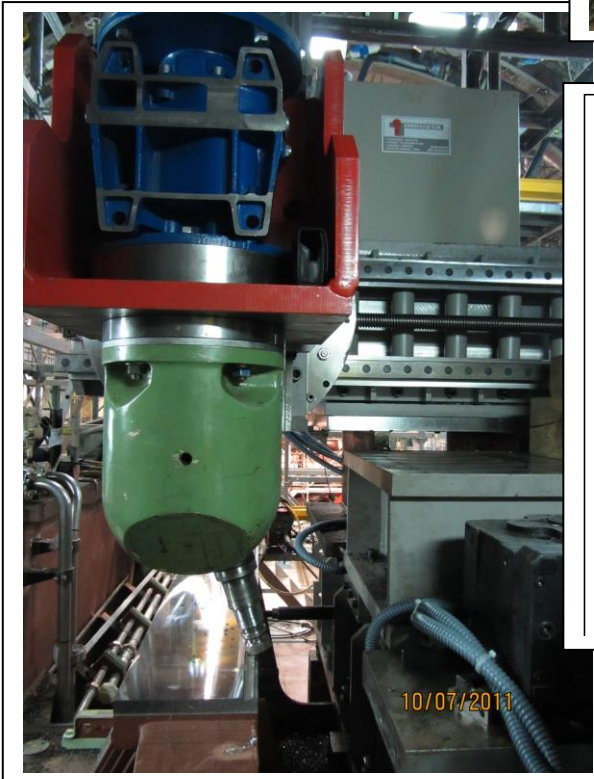

**SECTOR PAPELERO**

**PAPER INDUSTRIES**

**SECTOR NAVAL**

**SHIPPING INDUSTRIES**



## MECANIZADO EN GENERAL GENERAL WORKSHOP MACHINING

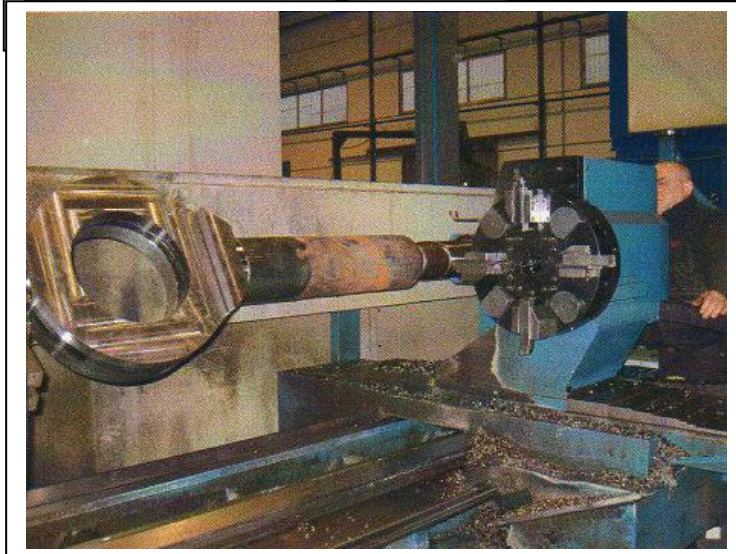

**INDUSTA** realiza todo tipo de trabajos de mecanizado según el encargo y las necesidades del cliente. Nuestras instalaciones cuentan con amplios medios y disponemos de profesionales cualificados para el desarrollo de cualquier proyecto. Trabajamos con todo tipo de materiales: aceros, aceros inoxidable, titanio, bronce, latones, aluminios, duraluminio, nylon, teflón, etc... en todos sus procesos de fabricación: laminado, fundición, forja, centrifugado, etc..

**INDUSTA** makes any kind of machining works, according to the customer's requirements and specifications. Our installations have a complete range of machines, including CNC machining centers operated by qualified professionals. There is not limit for the **raw material** to be machined, steel, stainless steel, aluminium, bronze, brass, titanium, nylon, teflon, cast metals, etc.





**MECANIZADO EN GENERAL  
GENERAL WORKSHOP MACHINING**

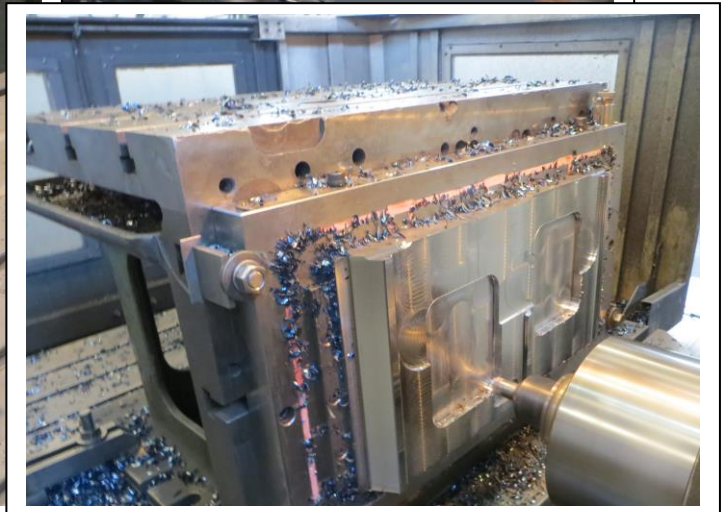



**MECANIZADO DE PRECISIÓN  
PRECISION MACHINING**

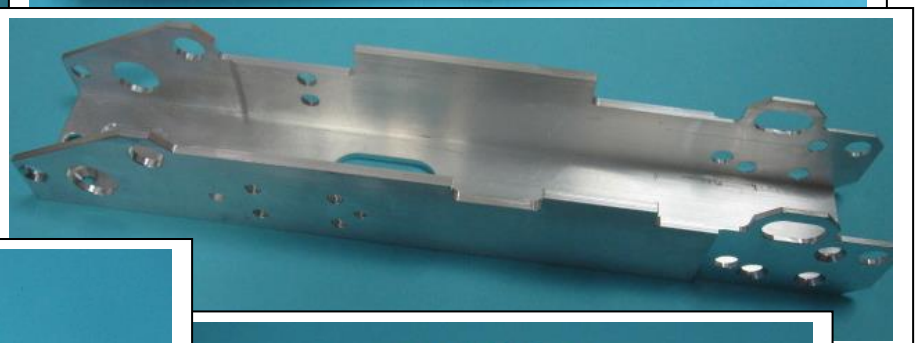



**MECANIZADO DE PRECISIÓN  
PRECISION MACHINING**

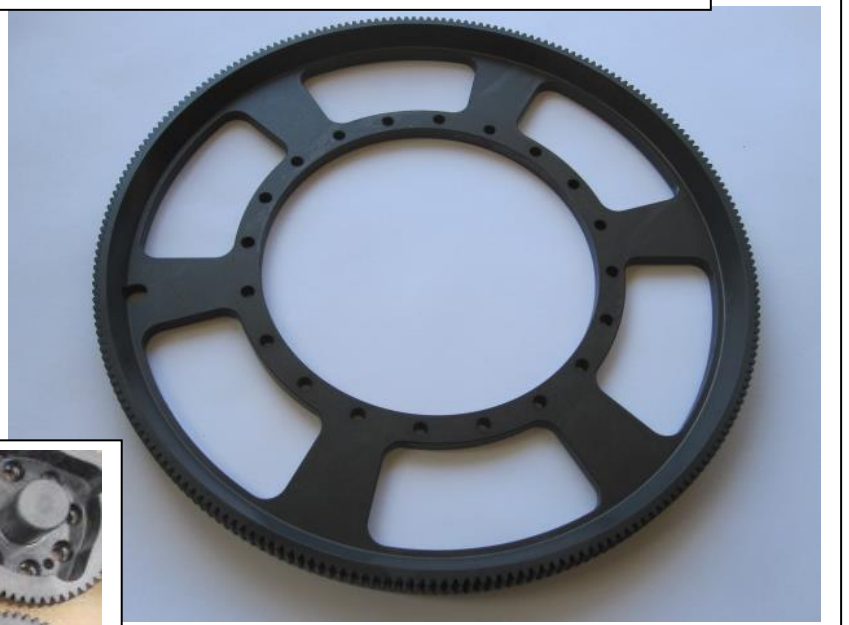



**MECANIZADO EN 5 EJES**  
**5 AXES MACHINING**

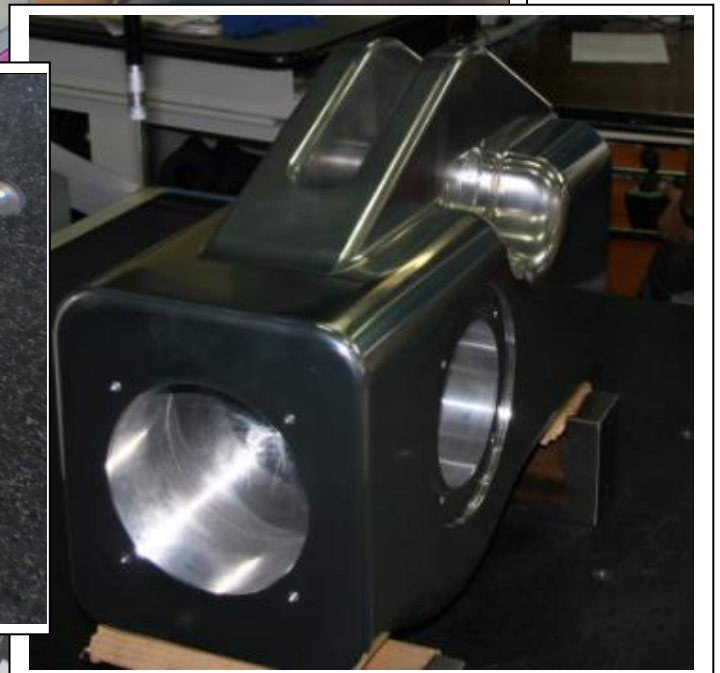



**CALDERERÍA Y SOLDADURA  
WELDING & STEEL CONSTRUCTION**



**INDUSTA** cuenta con personal experimentado y certificado, disponiendo de amplias instalaciones y con medios adecuados para realizar trabajos de soldadura básica y avanzada.

**Aceros al carbono e inoxidables:** Entre nuestros trabajos se encuentran armazones de máquinas, plataformas, estructuras, protecciones y conjuntos semifabricados para su posterior mecanizado en nuestros talleres.

**Aluminio:** **INDUSTA** tiene una gran experiencia y medios en la soldadura de aluminios y fundiciones.



**INDUSTA** has skill, qualified and certified welders having adequate facilities and equipment to carry out welded constructions.

**Carbon and stainless steel:** Among our works we can mention machinery structures, platforms, metallic structures, protections and semi-finished assemblies to be machined in our workshops.

**Aluminium:** **INDUSTA** has a wide experience in welding all Aluminium alloys.

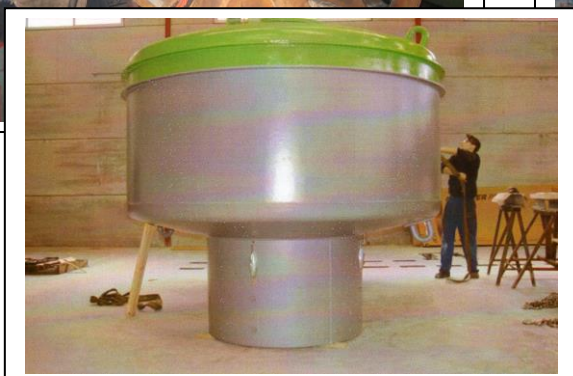
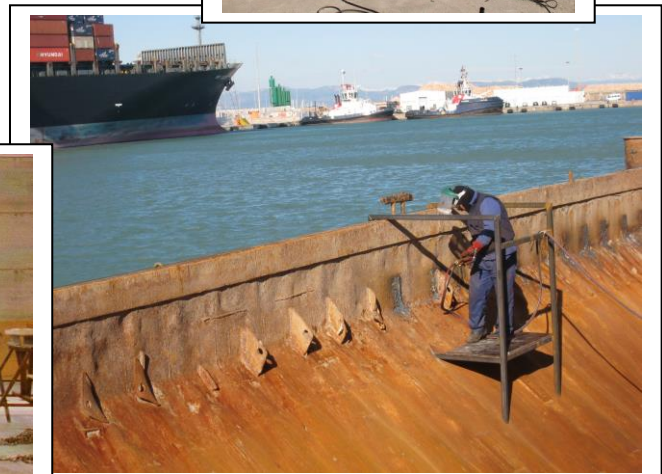

## ESTRUCTURAS DE ENCOFRADOS CONCRETE MOULD STRUCTURES

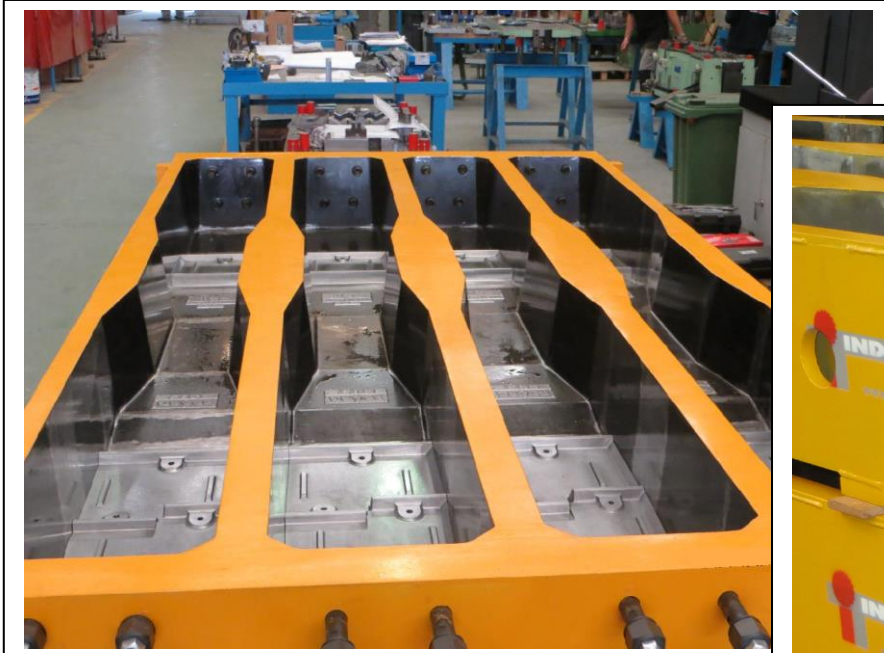

**INDUSTA** tiene en su historial de proyectos, la construcción de series de estructuras para encofrados de alta precisión. La combinación de la actividad de mecanizado y de soldadura nos permite acometer la fabricación de este singular tipo de estructuras complejas.

**In INDUSTA's** projects there are several contracts for the construction of **concrete mould structures** with a high dimensional accuracy requirements. The combination of welding and machining activity permit us to carry out these kind of singular construction with successful results.



**INDUSTA** dispone de los medios suficientes para garantizar que estas estructuras cumplen los estrictos requerimientos dimensionales para que los prefabricados que se obtengan alcancen la repetitibilidad e intercambiabilidad necesarias en sus proyectos.

For these type of contracts and products **INDUSTA** has the **necessary resources** to comply with the **accuracy** of each unit as well as the repetitive and the interchangeable requirements of the concrete pieces produced in these moulds.

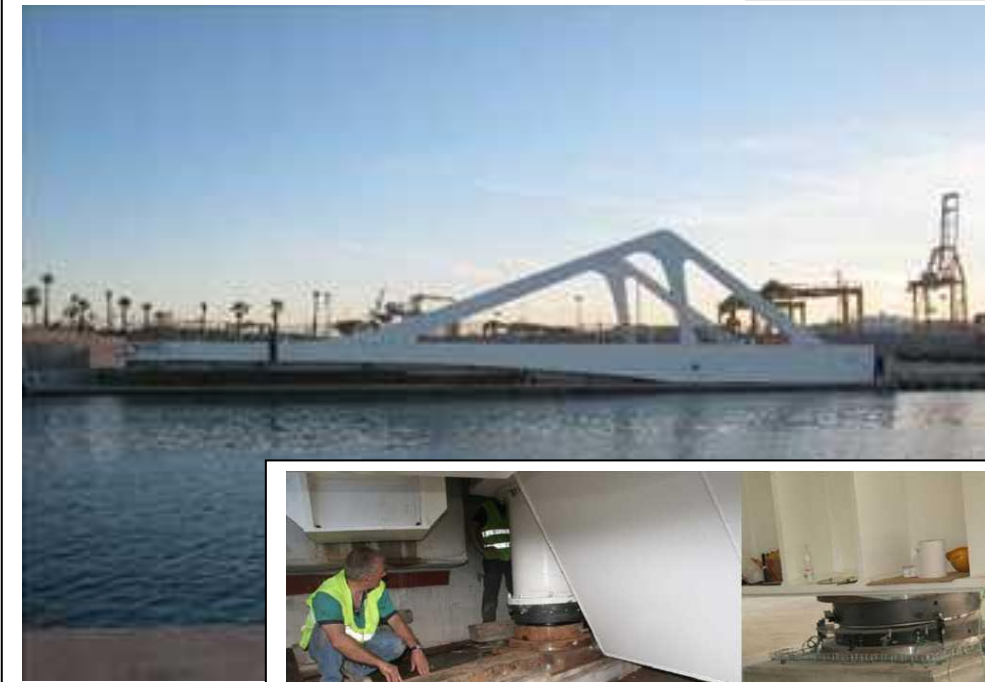

**MONTAJES ASSEMBLIES**

Hemos colaborado en la fabricación y montaje del Puente giratorio en el Puerto de Valencia, que forma parte del trazado del **Gran Premio de Fórmula 1**.

**INDUSTA** has collaborated during the manufacturing and assembly of the rotating bridge of Valencia Port which is part of the layout of F1 - Valencia GP.



Punto de apoyo Puente Giratorio Valencia.

Support point of the rotating bridge.

Carril rodadura Puente Giratorio Valencia.

Track tread of the rotating bridge.

Realizamos cualquier tipo de montaje metal-mecánico, desde ensamblajes sencillos hasta máquinas complejas, todo según los requisitos del cliente.

We make any kind of metal-mechanical assembly, from simple assemblies up to complex machines all in accordance with the customer's specifications.



## MATRICERÍA DIE METAL STAMP TOOLING

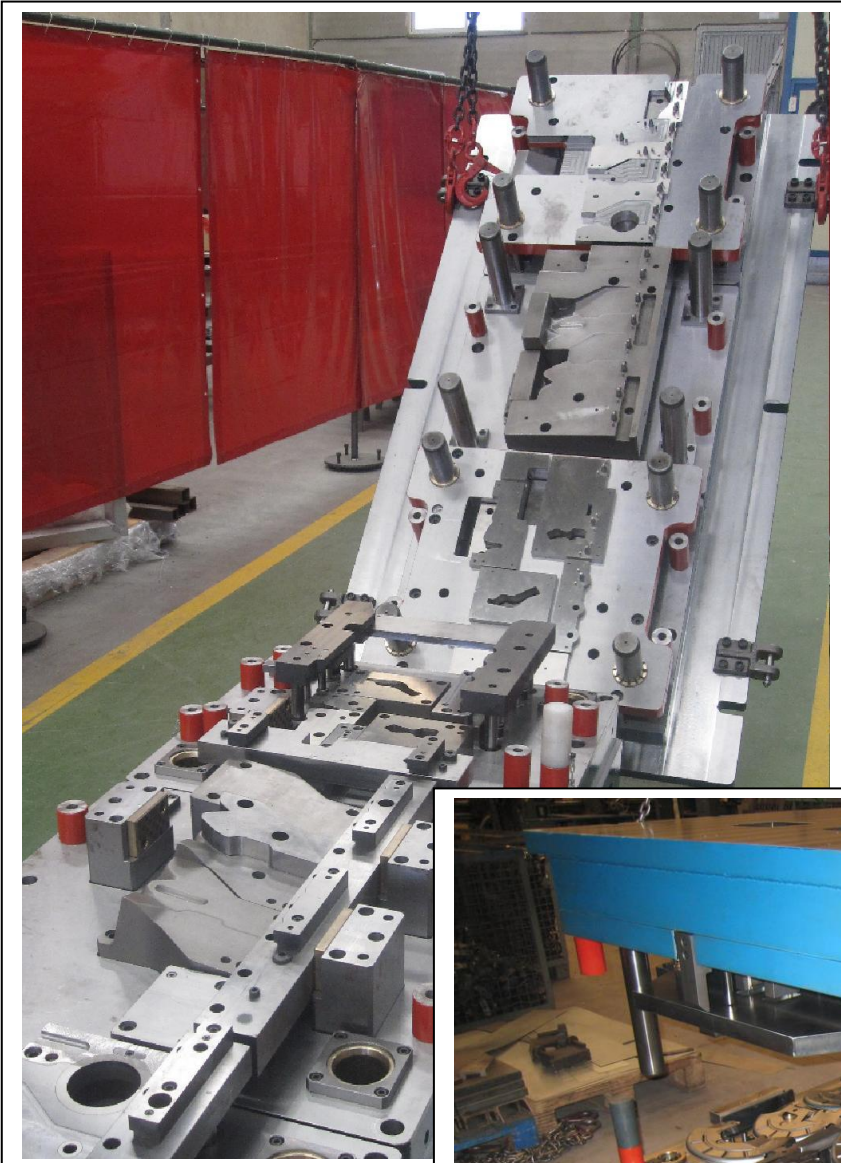

Otra de las líneas de actividad en las que **INDUSTA** destaca es la del desarrollo y construcción de matrices para la estampación metálica progresiva. Entre nuestros clientes figuran firmas de prestigio que suministran componentes a grandes marcas de automóviles y que confían en **INDUSTA** para la fabricación de sus matrices.

El desarrollo incluye las pruebas y preseries realizadas en una prensa hidráulica propia de 400 Tn.

**INDUSTA** asume todos los trabajos derivados desde la pieza prototipo facilitada por el cliente, hasta la entrega final de las matrices con sus certificados de funcionalidad, en estrecha colaboración con los técnicos del cliente a lo largo de todo el proceso.



Another **INDUSTA's** activity is the development and construction of die metal stamp tooling for the progressive metal stamp processes.

Among our clients, there are high reputed companies which are suppliers for the car industry, and they entrust to **INDUSTA** the complete development of their stamp tooling.

This development includes the necessary stamping test, prior to enter into production, which are made in our **hydraulic press of 400 Tn.**

**INDUSTA** assumes all involved works in this process, from the reception of the sample piece to be obtained up to the commissioning, in a close collaboration with the engineers of our clients.



**MATRICERÍA DIE METAL STAMP TOOLING**

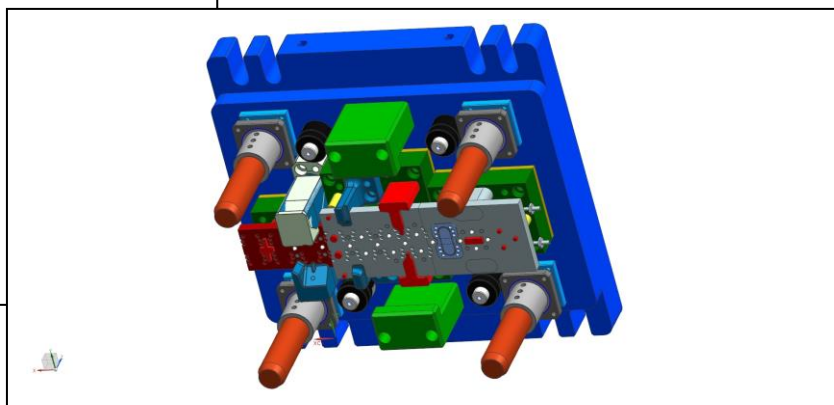
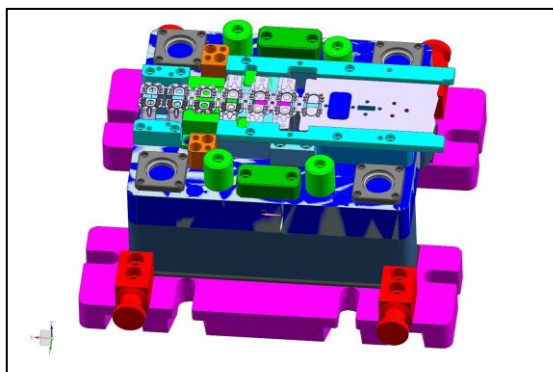
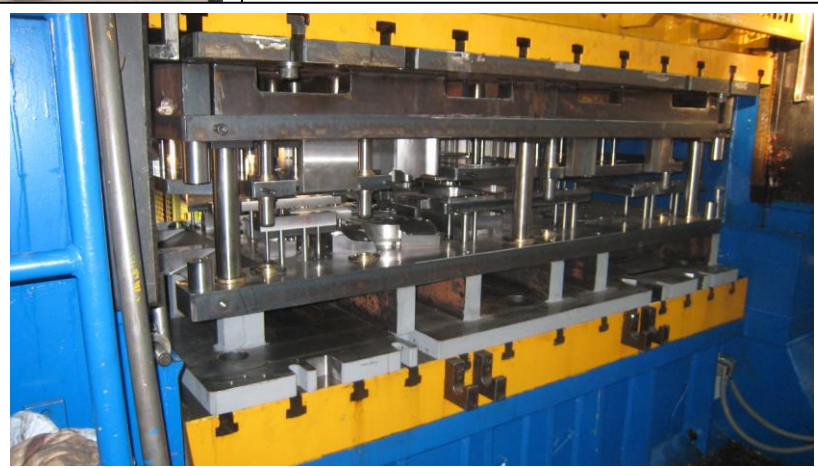
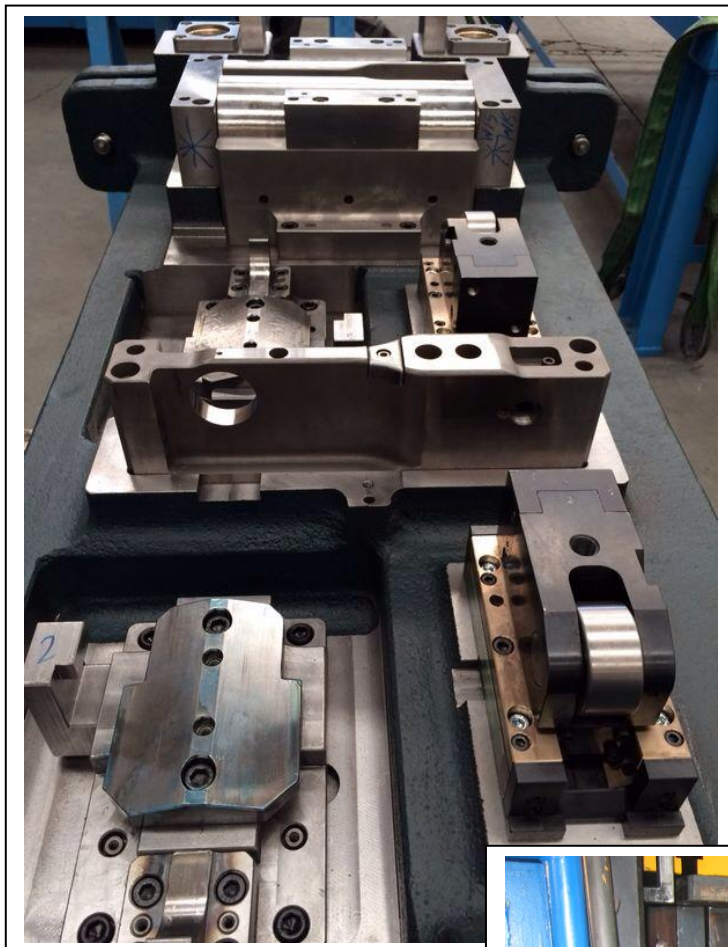

# DISEÑO & INGENIERÍA DESIGN & ENGINEERING

**INDUSTA** cuenta con una Oficina Técnica con profesionales que diseñan y apoyan el desarrollo de los proyectos de nuestros clientes incluyendo estaciones **Siemens NX** para **diseño y mecanizado en 3D (CAD/CAM)** para servicios internos y externos.

**INDUSTA** has a complete Design Office where our engineers design and develop machines and components, supporting our clients in their processes by using Siemens NX stations for the 3D design and machining (CAD /CAM).

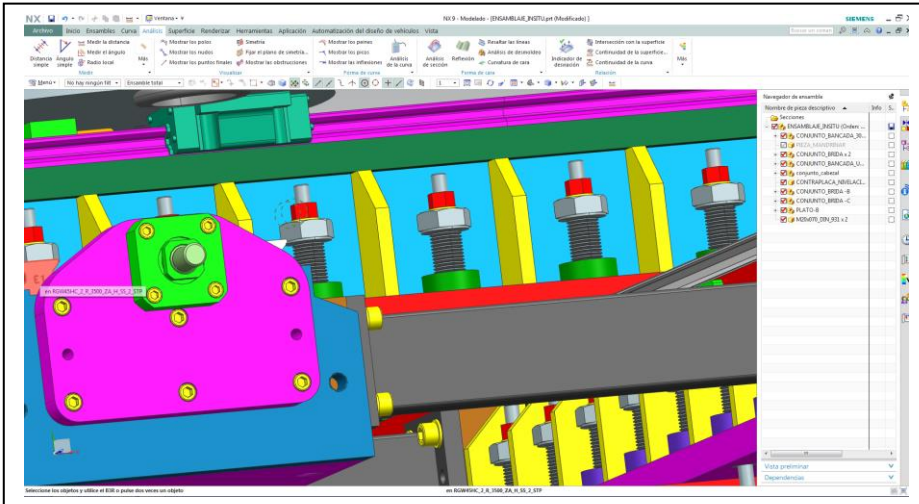

Con **Siemens NX**, se modeliza la máquina o componente, y se visualiza su movimiento en la máquina pudiendo verificar alcances e interferencias antes de iniciar su fabricación.

Supported by **Siemens NX** it's possible to make a model of the machine or component and check their properties and movements range to correct any interference before to launch it to manufacturing.

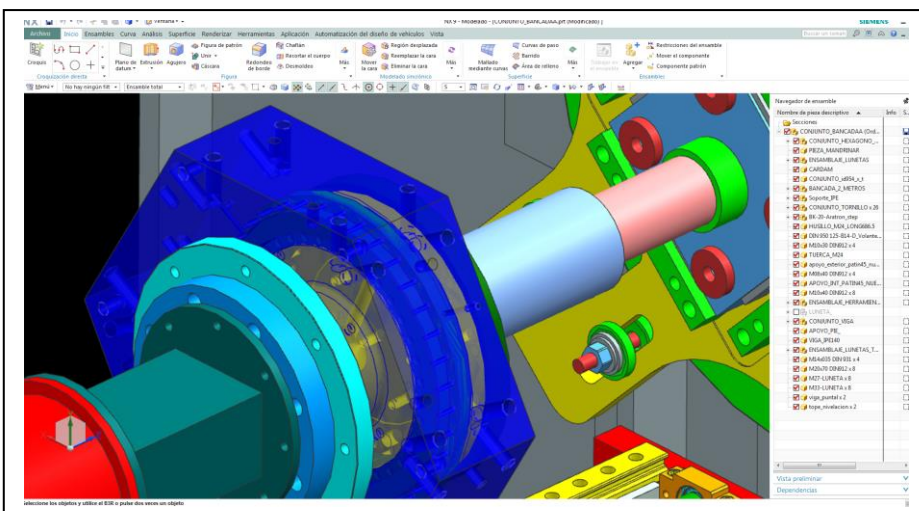
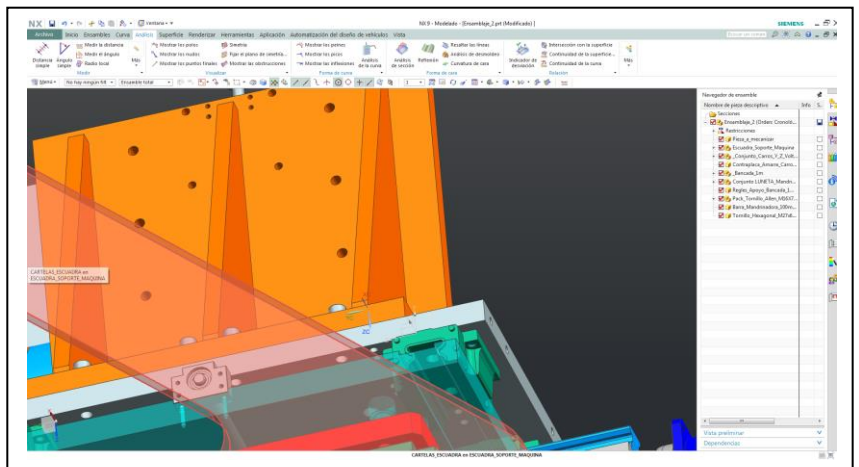

## METROLOGÍA METROLOGY

Sala de medición metrológica, aislada de vibraciones y agentes externos, con temperatura y humedad controladas. Medios de elevación y manipulación independientes.

Máquina **CNC Tridimensional DEA Image 12.20.10**, con capacidad útil de 2200 x 1200 x 1000.

In our facilities there is a measuring room isolated against vibrations and with temperature and humidity controlled. This room is equipped also with dedicated lifting and transportation device. Inside a **CNC Tridimensional DEA Image 12.20.10**, is installed with a measuring range of 2200 x 1200 x 1000 mm.

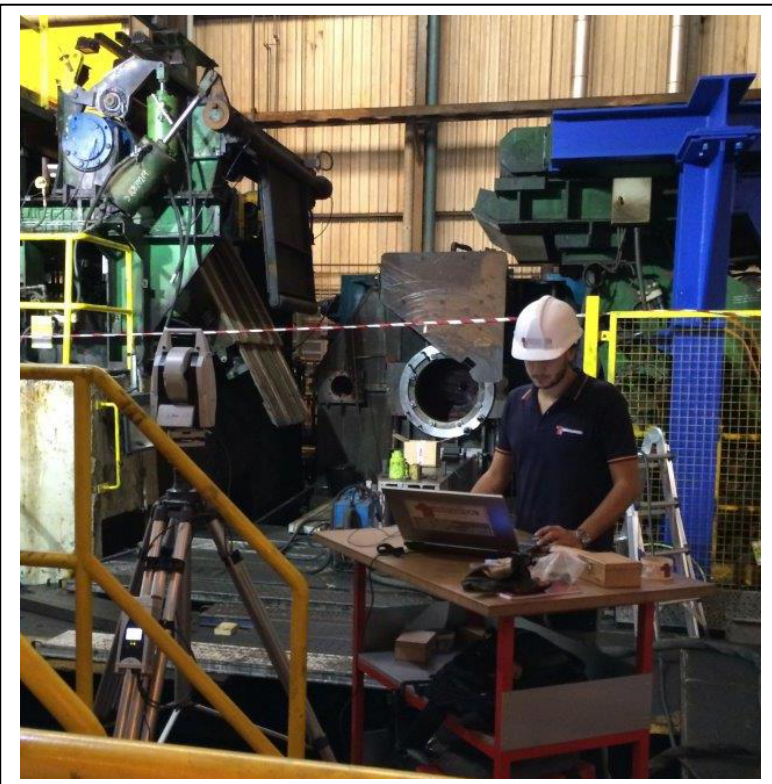

Los profesionales de **INDUSTA**, realizan sus mediciones tanto en la propia sala de metrología, como desplazándose a pie de obra.

**INDUSTA's** technicians perform their measurements tasks at our facilities as well outside, depending of the nature of Project.



Braza de medición **Romer Sigma 2030** para grandes escalas, con una capacidad útil de 1200 mm de radio.

Measuring Arm **Romer Sigma 2030** sized for big scales and a scope of 1200 mm in radius.

Estaciones de medición láser tracker de las marcas **LEICA** y **FARO**.

Measuring stations laser tracker of makers **LEICA** and **FARO**.



**METROLOGÍA METROLOGY**



**SECTOR NAVAL** *SHIPPING INDUSTRY*

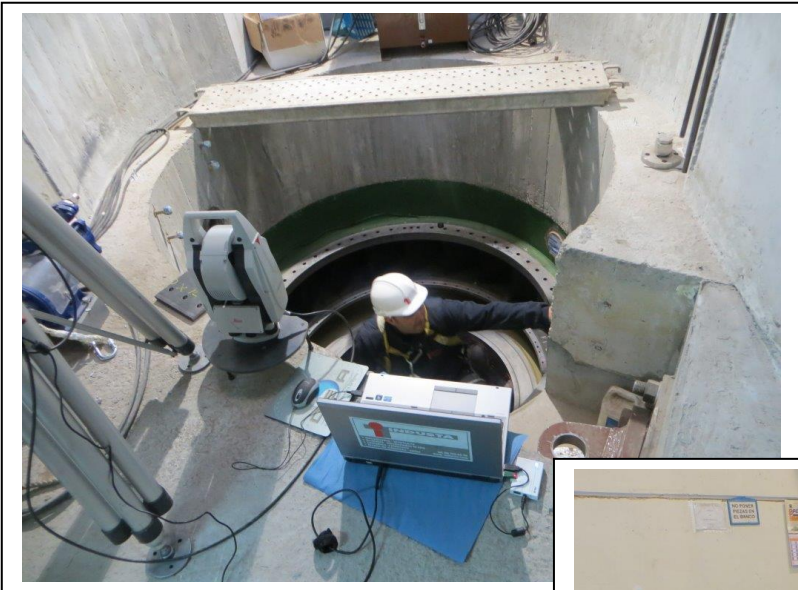
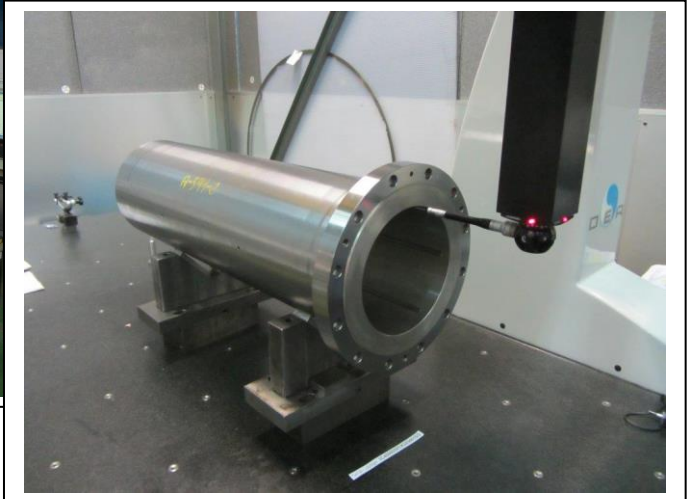

**SECTOR ENERGÍA**  
*ENERGY SECTOR*

**SECTOR AERONÁUTICO**

*AEROSPACE INDUSTRY*





**METROLOGÍA METROLOGY**

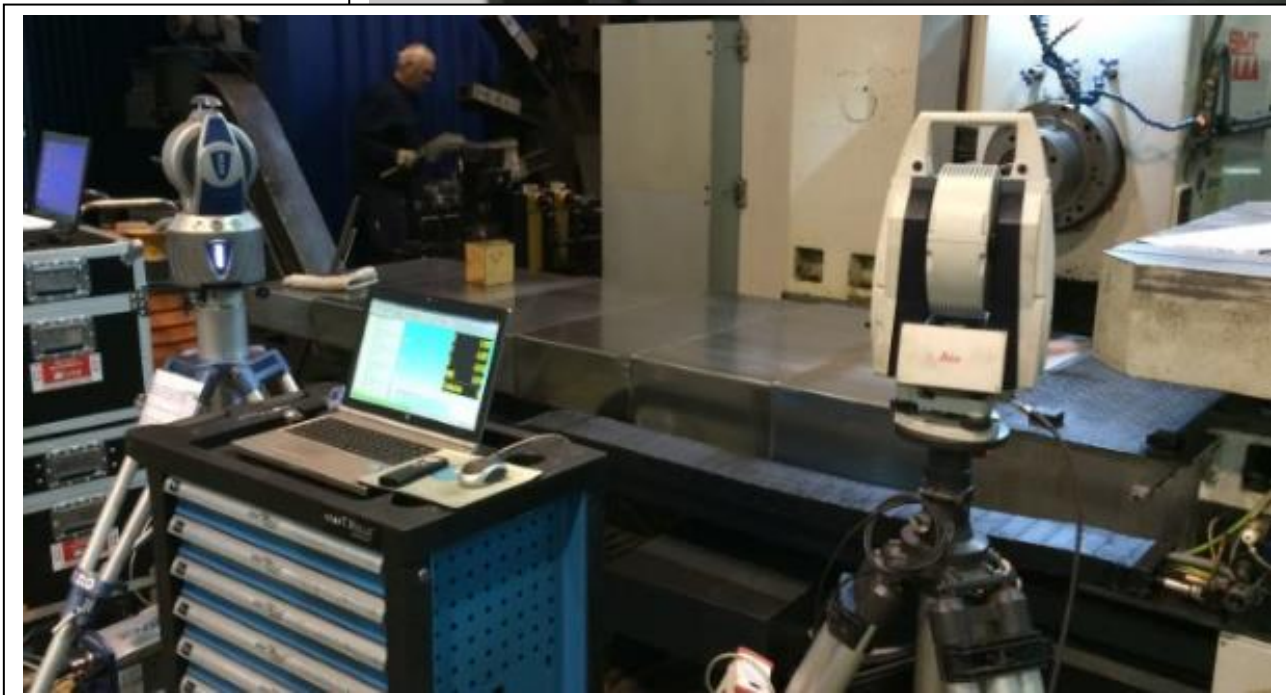



*INDUSTA se encuentra en Moncada, a 15 km al Norte de Valencia.  
INDUSTA is located in Moncada, and it is 15 km to the North of Valencia.*

**N - 39° 34' 56" // W - 0° 23' 06"**

**C/ La Palmera, 4 - Pol Ind. de Moncada  
46113 MONCADA (Valencia) España  
+34 96 139 98 40**

**e-mail: [comercial@industa.com](mailto:comercial@industa.com)**

**[www.industa.com](http://www.industa.com)**

